

Cable Railing Kit “How To” Guide for Metal Posts



March 1, 2014

218 Stewart Rd SE
Pacific, WA 98047

P: 253-833-4343

F: 253-833-4545

W: americanstructures.com



Made in
the U.S.A.



ISO 9001
QMI-SAT Global



Framework You Will Need for Cable Railing

End Post Construction

Since hundreds of pounds of tension is being applied to end posts using cable railing, those posts must be substantial enough to handle that tension.

For metal posts, kits are designed for use with 1½" square, 2" square, and 2-3/8" square tube. Steel posts will need to be a minimum 1/4" wall to handle the load when the cables are tensioned; intermediates can be 1/8". You will need a top rail. For aluminum, your end posts should be reinforced and you may want to consider a bottom rail to help prevent post-bowing. End posts must be securely mounted to the deck to prevent the post from coming loose when the cables are tensioned.

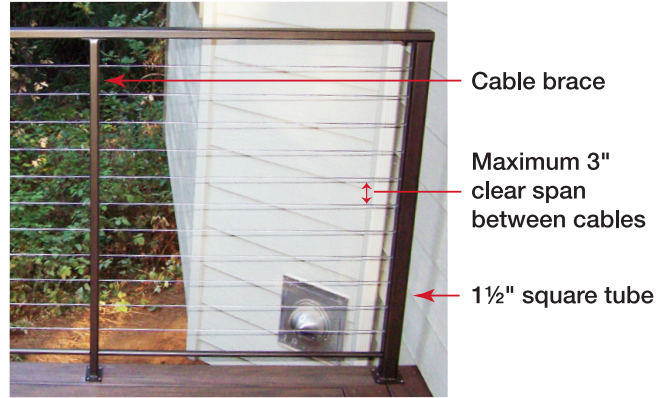

Intermediate posts between end and corner posts

To keep the cable from spreading beyond IBC code requirements, we recommend that the cable be supported in some manner no more than every 42" along its run. Intermediate posts, through which the cable is strung, act as supports for the cable. To avoid having to use more intermediate posts than is structurally necessary, a thin metal cable brace with holes for the cables to pass through can be used to

support the cables (see illustrations). A typical cable brace is either 3/4" x 3/4" aluminum tube or 1/4" thick by 1" wide stainless steel flat bar and is ordered separately.

Cable spacing on your posts

We recommend that you space the cables with no more than a 3" clear span between the cables (see illustrations). For example, if you are using 3/16" diameter cable, you would drill your holes on center no more than 3-3/16" apart.

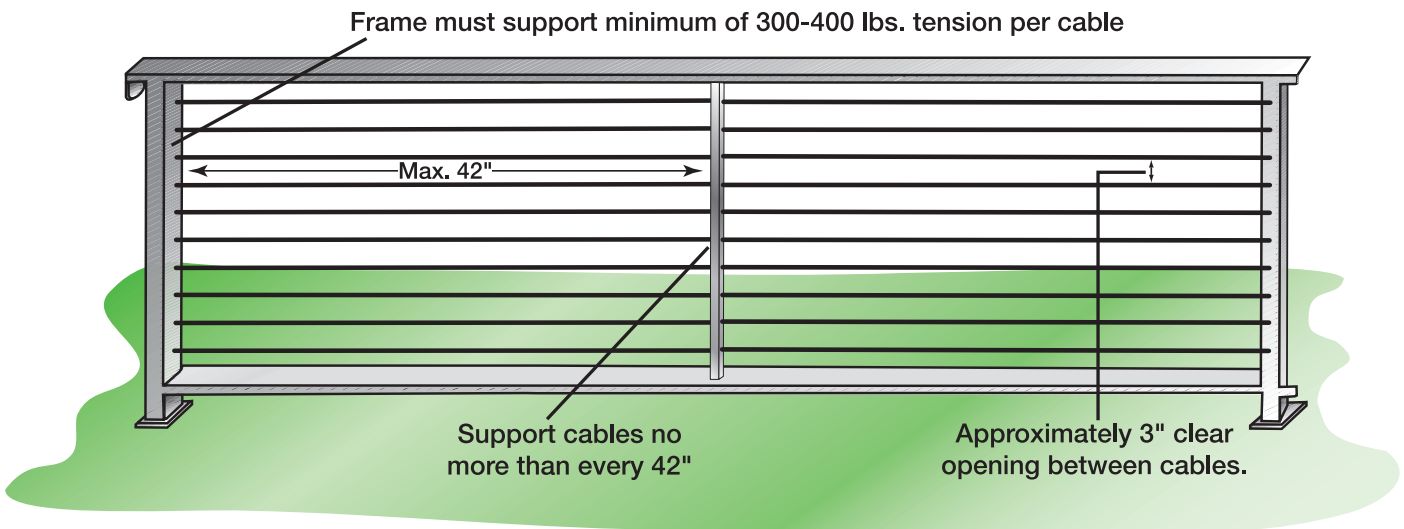

Your Deck Type

Decks come in all shapes and sizes, but there are only a few types of cable runs that go on those decks: inside-of-post to inside-of-post, inside-of-post to outside-of-post, and outside-of-post to outside-of-post. The following illustrations represent several ways you can run cable on your deck. Every run will require a fitting that will act to tension the cable once installed. Depending on the length of the run, the tensioning device in the kit, and whether you plan to bend the cable through a corner, you will either be able to use a

non-tensioning Push-Lock™ or Pull-Lock™ on the other end or you will need to use a Push-Lock tensioner on the other end.

The VIP Run

You will see that Run #1 on each drawing is the “view run” — the one that is most important, most visible of all your runs. It’s the one on which you want to have the least interference with the view, so you always start with that run and build around it.



218 Stewart Rd SE, Pacific, WA 98047
P: 253-833-4343 • F: 253-833-4545
www.americanstructures.com

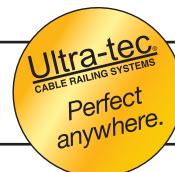

Ultra-tec
CABLE RAILING SYSTEMS

A Closer Look at Corner Posts

Where Two Cable Runs Intersect

While you can offset cables on intersecting runs to use less expensive fittings, most people want all their cables to exist on the same plane, to give the impression that cables are continuous.

Ultra-tec fittings are designed to be able to reside within the same post in many configurations. Below are some examples of how your kit components work together.

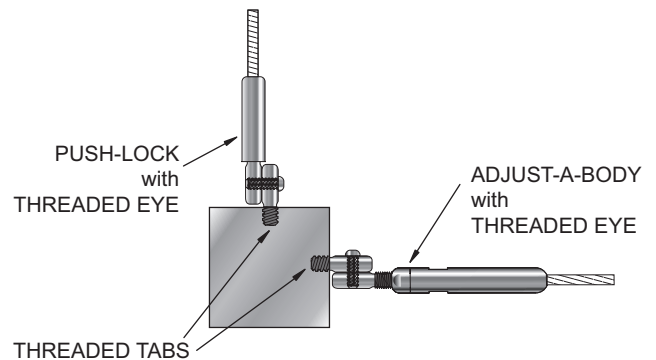
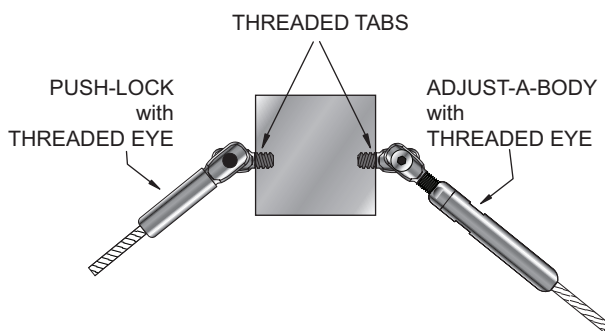
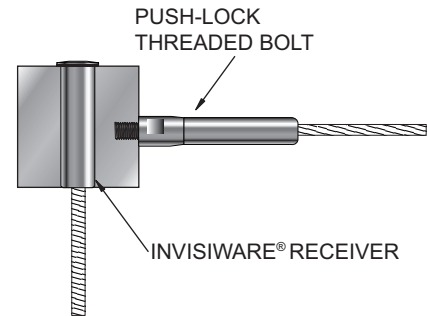
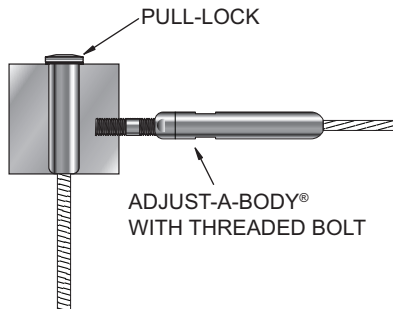

Continuing a Cable Run Through a Corner

When taking cable railing through a corner, do not bend the cable past 45° at any time. If turning 90°, a 2-step turn using a double corner post configuration is required, as illustrated. For metal frame cable runs with up to 90° of turn, kits with single tensioners are sufficient. If going through corners totaling more than 90°, you will want to use a kit with tensioners at both ends.

Corners require two posts because the cable itself, being rigid, will not cooperate in bending cleanly through a single post.

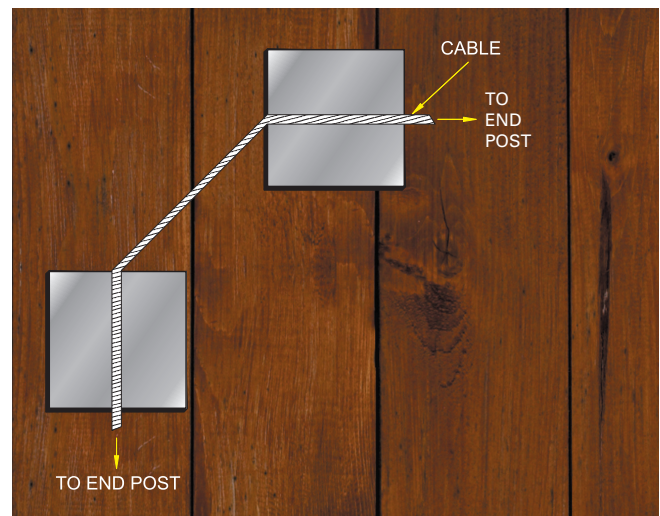

Kit Assemblies at a Glance for Metal Posts



For level runs:

- 200 Series* (outside to outside)
Invisiware Receiver to Pull-Lock.
- 272 Series (outside to outside)
3½" Invisiware Receiver to
1½" Receiver with Push-Lock Stud.
- 700 Series* (inside to outside)
Invisiware Receiver to Push-Lock with Threaded Bolt.
- 773 Series (inside to outside)
Adjust-a-Body with Threaded Bolt to
1½" Receiver with Push-Lock Stud.
- 401 Series (inside to inside)
Adjust-a-Body with Threaded Bolt to
Push-Lock with Threaded Bolt.
- 471 Series (inside to inside)
Adjust-a-Body with Threaded Bolt
to Push-Lock Turnbuckle with Threaded Bolt.

* 212 and 702 series are for use with 1½" metal posts;
232 and 703 are for use with 2" metal posts;
224 Series is for use with 2-3/8" metal posts.

For stairs, pitched runs:

- 200 Series* (outside to outside)
Invisiware Receiver to Pull-Lock with beveled washers.
- 500-M Series (inside to inside)
Push-Lock with Threaded Eye to
Adjust-a-Body with Threaded Eye.
Threaded tabs on both ends.

Recommendations for metal railings:

Outside attachments can only be used if your end posts are not obstructed on the back side: Series 200 or 272; Series 700 or 773 if only one end is obstructed.

If you are unable to access the back side of your end posts, then you will need to use a series with an inside attachment: Series 400, 471 or 500-M if both ends are obstructed; Series 700 or 773 if only one end is obstructed.

If you are installing a railing with a pitch, you will need a series that can be run on an angle: Series 200 or 500-M. Corners require two posts because the cable itself, being rigid, will not cooperate in bending cleanly through a single post.

Warranty: Stainless steel hardware and cable are covered by a limited warranty for a period of ten (10) years from the date of receipt to be free from defects due to defective materials and workmanship.

For complete warranty details, please visit <http://thecableconnection.com/warranty-ultra-tec.html>



218 Stewart Rd SE, Pacific, WA 98047
P: 253-833-4343 • F: 253-833-4545
www.americanstructures.com

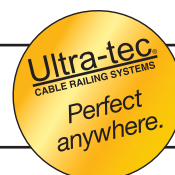

Ultra-tec
CABLE RAILING SYSTEMS

Metal Posts Outside-of-Post to Outside-of-Post Mount

Straight Cable Runs up to 25 feet

Deck 1 has dedicated end posts for each run, and the posts are situated such that the back side of the posts are all accessible, meaning you can use an *outside-of-post to outside-of-post* configuration for all runs. This is both the most economical solution and where the fittings are least visible.

For 1½" posts, applicable kit is the 212 Series.
For 2" posts, applicable kit is the 232 Series.
For 2-3/8" posts, applicable kit is the 224 Series.

The tensioning device is, respectively, a 1½", 2", or 2-3/8" long Receiver, which installs through the metal post on one end. A Pull-Lock fitting of the same length is installed through the other end.

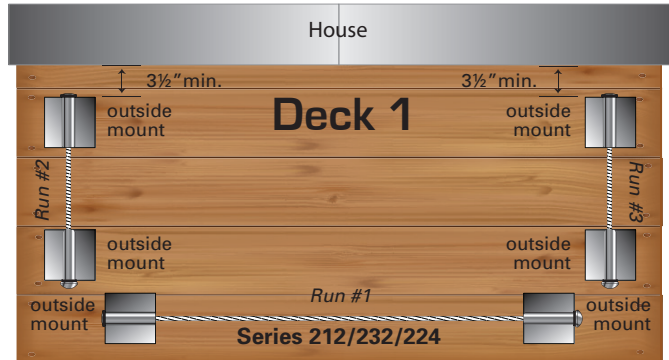
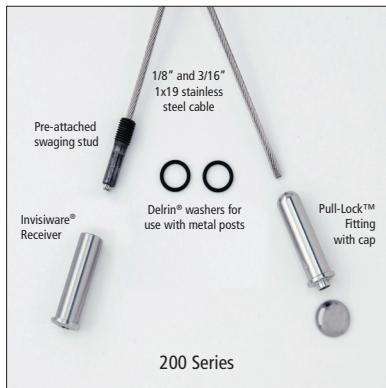

Series 212, 232, and 224 Kits

Cable Length	1/8" cable			3/16" cable		
	1½" metal post	2" metal post	2-3/8" metal post	1½" metal post	2" metal post	2-3/8" metal post
5'	21205	23205	22405	21205-6	23205-6	22405-6
10'	21210	23210	22410	21210-6	23210-6	22410-6
15'	21215	23215	22415	21215-6	23215-6	22415-6
20'	21220	23220	22420	21220-6	23220-6	22420-6
25'	21225	23225	22425	21225-6	23225-6	22425-6

Cable Runs over 25 feet

Longer cable runs need more take-up in the tensioning device, so the 224 Series stands in for the 212 and 232 for long runs and cable runs through one corner.

When taking cable railing through a corner, do not bend the cable past 45° at any one time. If turning 90°, a 2-step turn using a double corner post configuration is required, as in Deck 2.

Applicable kit is the 224 Series.

The tensioning device is a 2-3/8" long Invisiware® Receiver, which installs through the metal post on one end. A Pull-Lock fitting of the same length is installed through the other end.

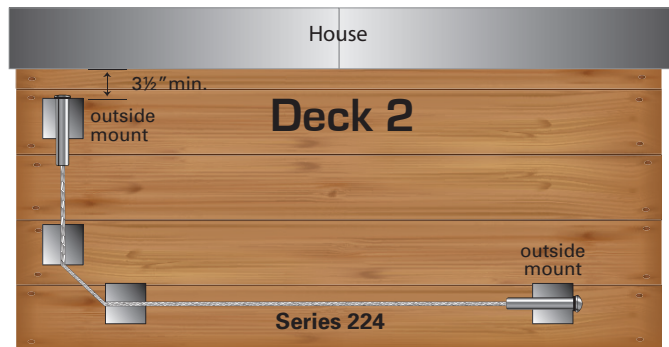

Depending on the size of your metal posts, the 224 Series fittings may extend beyond the width of the posts.

Series 224 Kits

Cable Length	1/8" cable	3/16" cable
	PART NO.	PART NO.
30'	22430	22430-6
40'	22440	22440-6
50'	22450	22450-6

Tools needed for 212, 232, and 224 Series:

- 5/32 drill bit if 1/8" cable, 7/32 if 3/16"
- 29/64 drill bit for Receiver and Pull-Lock installation
- 3/16 Hex wrench for tensioning Receiver
- Cable cutting tool

Outside-of-Post to Outside-of-Post Mount _____ Metal Posts

Cable Runs through Two Corners

When going around two corners, it's necessary to tension the cable from both ends as shown in Deck 3.

Applicable kit is the 272 Series.

The tensioning devices are a 3½" long Invisiware Receiver, which installs through the post on one end, and a Push-Lock Stud on the other end, which is threaded into a 1½" long Receiver.

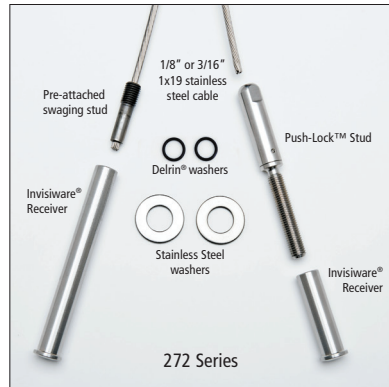

Since the 272 Series is also used for wood posts, the kits include stainless steel washers.

Series 272 Kits

Cable Length	1/8" cable	3/16" cable
	PART NO.	PART NO.
30'	27230	27230-6
40'	27240	27240-6
50'	27250	27250-6
60'	27260	27260-6

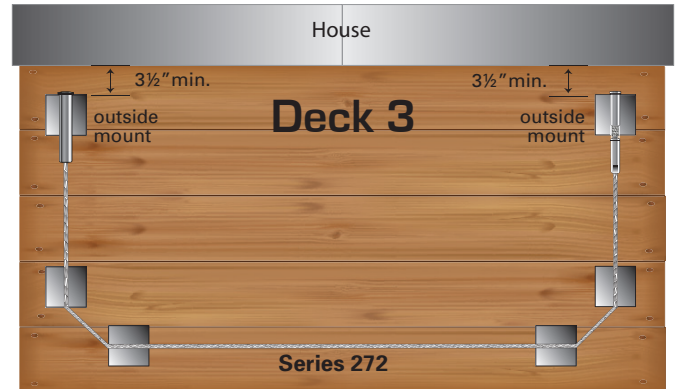

Tools needed for 272 Series:

- 5/32 drill bit if 1/8" cable, 7/32 if 3/16"
- 29/64 drill bit for Receivers and Pull-Lock installation
- 3/16 Hex wrench for tensioning Receiver
- Cable cutting tool
- 7/16 wrench for tightening Push-Lock Stud



Metal Posts Inside-of-Post to Outside-of-Post Mount

Straight Cable Runs up to 25 feet

Deck 1 has dedicated end posts, but the posts next to the house are too close to access the back side of the posts. Run #1 is outside to outside, so it will take a Series 212 or 232 kit. However, for Runs #2 and #3, you will attach to the *inside* of the posts next to the house and run *through* the post at the other end.

Deck 2 has shared corner posts, but the posts next to the house are placed such that the back side of the posts are accessible, so for Runs #2 and #3, you will attach to the inside of the corner posts and run through the post next to the house.

For 1½" posts, applicable kit is the 702 Series.

For 2" posts, applicable kit is the 703 Series.

The tensioning device is a 1½" (or 2") long Invisiware Receiver, which installs through the metal post on one end. A Push-Lock Threaded Bolt is threaded into the other end.

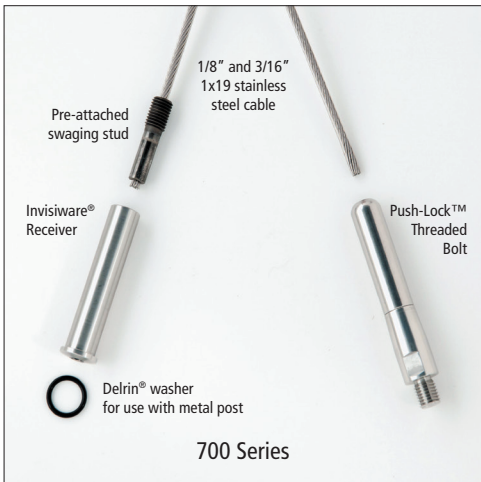
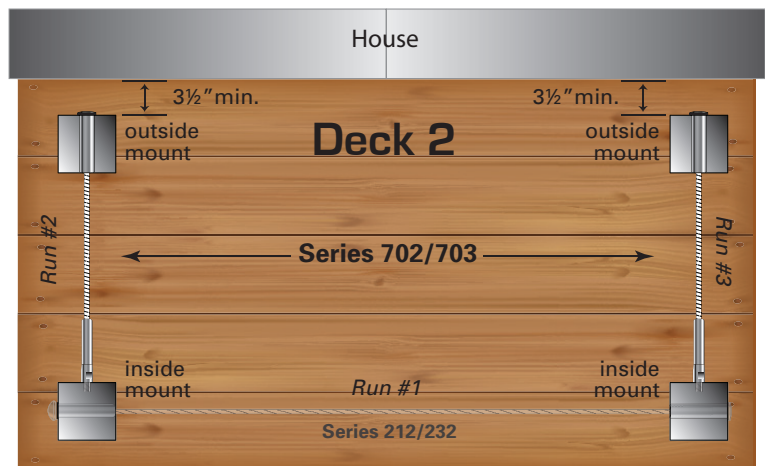
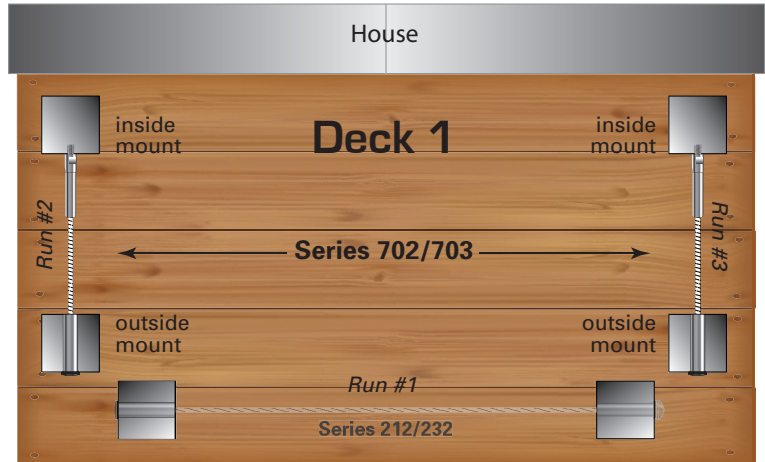

Tools needed for 702 and 703 Series:

- 5/32 drill bit if 1/8" cable, 7/32 if 3/16"
- 29/64 drill bit for Receiver installation
- 3/16 Hex wrench for tensioning Receiver
- Cutting tap drill bit I (for pilot hole) and 5/16-24 tap for Push-Lock Threaded Bolt installation
- 7/16 wrench for tightening Push-Lock Threaded Bolt
- Cable cutting tool

Series 702 and 703 Kits

Cable Length	1/8" cable		3/16" cable	
	1½" metal post	2" metal post	1½" metal post	2" metal post
	PART NO.	PART NO.	PART NO.	PART NO.
5'	70205	70305	70205-6	70305-6
10'	70210	70310	70210-6	70310-6
15'	70215	70315	70215-6	70315-6
20'	70220	70320	70220-6	70320-6
25'	70225	70325	70225-6	70325-6

Inside-of-Post to Outside-of-Post Mount _____ Metal Posts

Cable Runs over 25 feet

Longer cable runs need more take-up in the tensioning device, so the 773 Series stands in for the 702 and 703 for long runs and cable runs through corners.

When taking cable railing through a corner, do not bend the cable past 45° at any one time. If turning 90°, a 2-step turn using a double corner post configuration is required.

Deck 3 illustrates how to go around a single corner up to 90° using the 773 kit; Deck 4 illustrates two corners.

Applicable kit is the 773 series

The tensioning devices are an Adjust-a-Body with Threaded Bolt, which threads into the metal post on one end, and a 1 1/2" long Receiver with Push-Lock Stud on the other end.



Cable Length	Series 773 Kits	
	1/8" cable PART NO.	3/16" cable PART NO.
30'	77330	77330-6
40'	77340	77340-6
50'	77350	77350-6
60'	77360	77360-6

Tools needed for 773 Series:

- 5/32 drill bit if 1/8" cable, 7/32 if 3/16"
- 29/64 drill bit for Receiver installation
- 3/16 Hex wrench for tensioning Receiver
- Cutting tap drill bit I (for pilot hole) and 5/16-24 tap for Adjust-a-Body with Threaded Bolt installation
- 1/4 wrench for installing threaded bolt of Adjust-a-Body with Threaded Bolt
- 7/16 wrench for tensioning Adjust-a-Body
- 3/8 wrench for tightening Push-Lock Stud
- Cable cutting tool

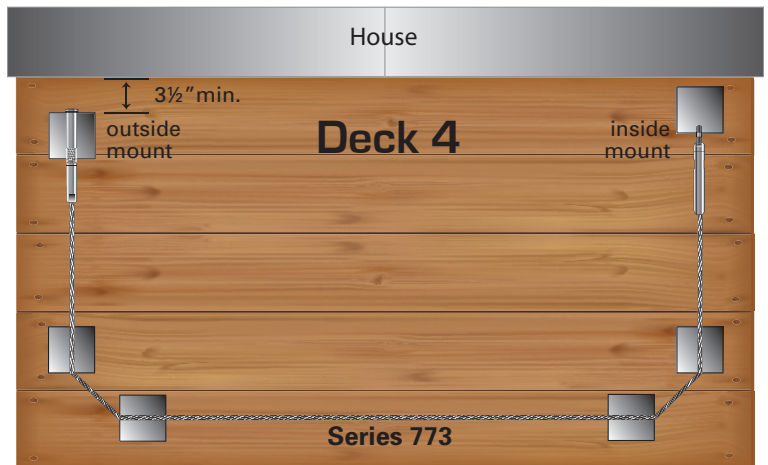
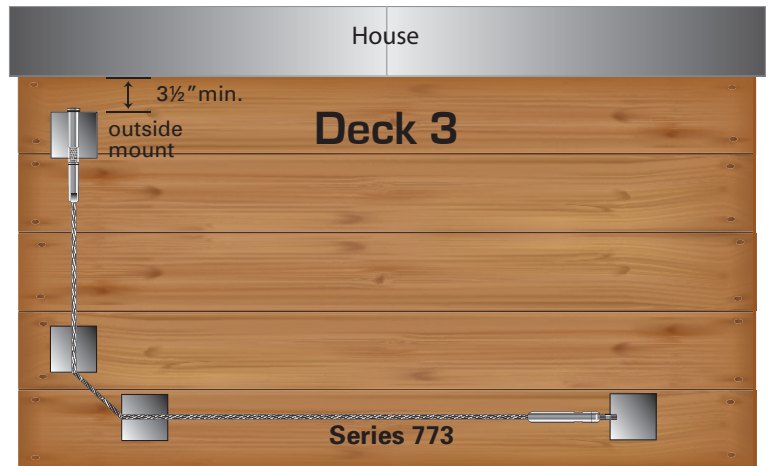

Tools needed for 401 and 471 Series (page 10):

- 5/32 drill bit if 1/8" cable, 7/32 if 3/16"
- Cutting tap drill bit I (for pilot hole) and 5/16-24 tap for threaded bolt installation
- 1/4 wrench for installing threaded bolts
- 3/8 wrench for tensioning Push-Lock Stud (471 Series only)
- 7/16 wrench for tensioning Adjust-a-Body (both series) and Push-Lock Threaded Bolt (401 Series only)
- Cable cutting tool



218 Stewart Rd SE, Pacific, WA 98047
 P: 253-833-4343 • F: 253-833-4545
 www.americanstructures.com

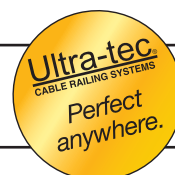

Ultra-tec
 CABLE RAILING SYSTEMS

Metal Posts Inside-of-Post to Inside-of-Post Mount

Straight Cable Runs and Cable Runs through One Corner

Deck 1 has only one end post at the corners. The posts next to the house butt right up to it so the back sides of those posts are not accessible. Run #1 is still outside to outside, so it will take a Series 212 or 232 kit. Runs #2 and #3 connect to the *inside* of the corner post going back toward the house to keep the cables on the same plane. They also connect to the *inside* of the posts next to the house as well.

When taking cable railing through a corner, do not bend the cable past 45°. If turning 90°, a double corner post configuration is required as illustrated in Deck 2.

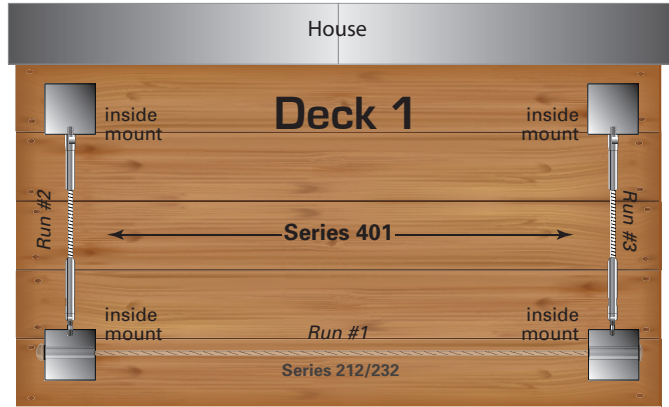

Applicable kit is the 401 Series.

The tensioning device is an Adjust-a-Body® with Threaded Bolt, which threads into the metal post on one end. A Push-Lock Threaded Bolt is threaded into the other end.

Cable Length	Series 401 Kits	
	1/8" cable PART NO.	3/16" cable PART NO.
5'	40105	40105-6
10'	40110	40110-6
15'	40115	40115-6
20'	40120	40120-6
25'	40125	40125-6
30'	40130	40130-6
40'	40140	40140-6
50'	40150	40150-6

Cable Runs through Two Corners

When going around two corners, it's necessary to tension the cable from both ends as shown in Deck 3.

Applicable kit is the 471 Series.

The tensioning devices are an Adjust-a-Body with Threaded Bolt, which threads into the metal post on one end, and a Push-Lock Turnbuckle with Threaded Bolt on the other end.

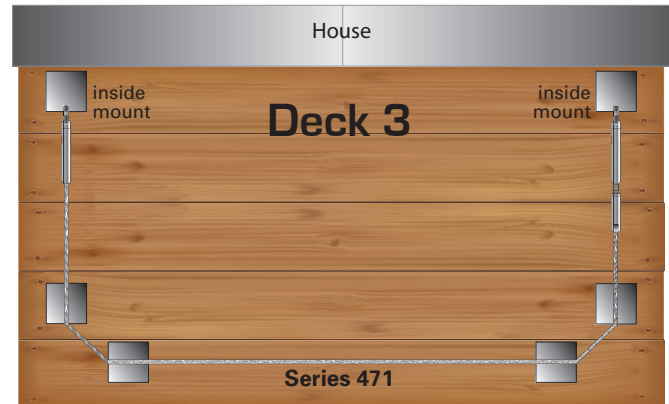
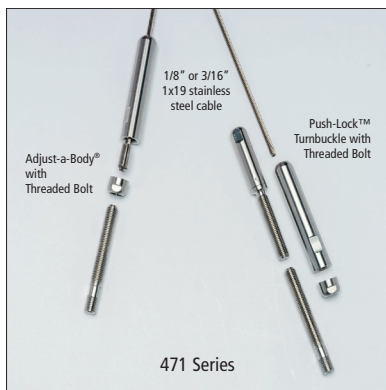

For Tools needed, see bottom of page 9.

Cable Length	Series 471 Kits	
	1/8" cable PART NO.	3/16" cable PART NO.
30'	47130	47130-6
40'	47140	47140-6
50'	47150	47150-6
60'	47160	47160-6

Inside-of-Post to Inside-of-Post Mount _____ Metal Posts on Stairs

Cable Runs on a Pitch

Top posts are often corner posts, which may require the stair run to connect to the *inside* of the post. The top and bottom of the cable run would be connected perpendicular to those posts, and only the intermediate posts would be drilled on the angle for the cable to run through.

Applicable kit is the 500-M Series.

The tensioning device is an Adjust-a-Body with Threaded Eye, which attaches via mounting screw to the threaded tab. A Push-Lock with Threaded Eye attaches the same way to the other end.

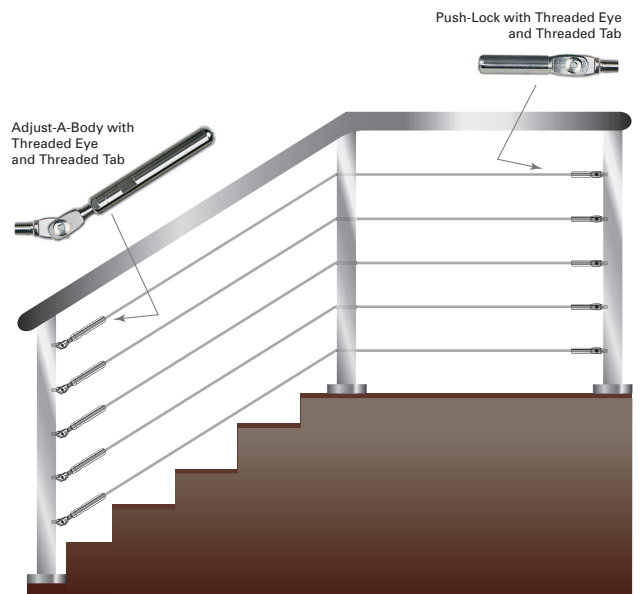
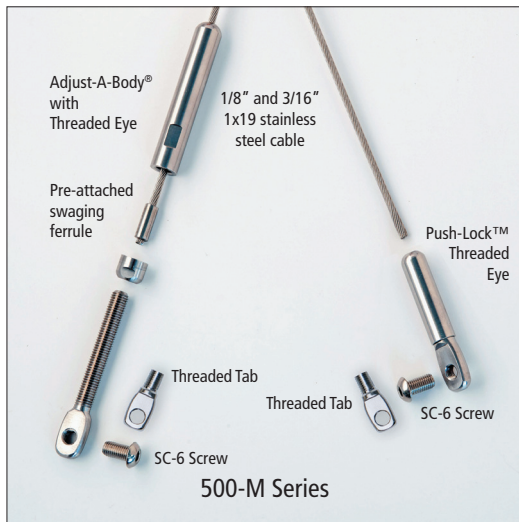
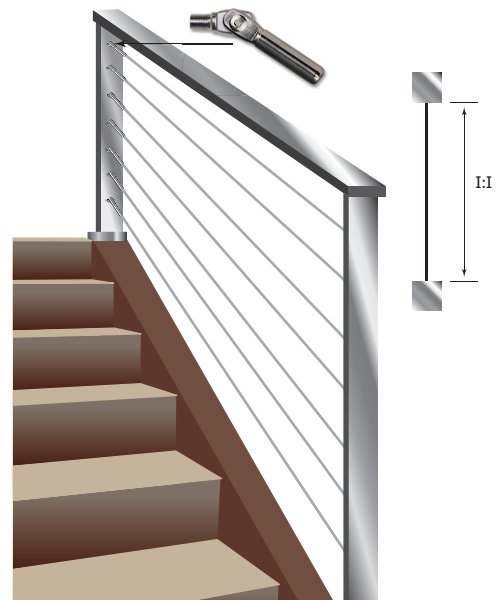

Series 500-M Kits for Metal Posts

	1/8" cable	3/16" cable
Cable Length	any size post	any size post
	PART NO.	PART NO.
5'	50005-M	50005-6M
10'	50010-M	50010-6M
15'	50015-M	50015-6M
20'	50020-M	50020-6M
25'	50025-M	50025-6M
30'	50030-M	50030-6M
40'	50040-M	50040-6M
50'	50050-M	50050-6M

Tools needed for 500-M Series on stairs:

5/32 drill bit if 1/8" cable, 7/32 if 3/16"

Cutting tap drill bit I (for pilot hole) and 5/16-24 tap for threaded tab installation

7/16 wrench for tensioning Adjust-a-Body

5/32 Hex wrench to tighten mounting screws

Cable cutting tool



218 Stewart Rd SE, Pacific, WA 98047
 P: 253-833-4343 • F: 253-833-4545
 www.americanstructures.com

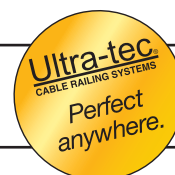

Ultra-tec
 CABLE RAILING SYSTEMS

Metal Posts _____ Outside-of-Post to Outside-of-Post Mount on Stairs

Cable Runs on a Pitch

The most economical approach is to go *through* both top and bottom end posts. The holes in the end posts, and any intermediate posts, must be drilled on the angle of the stairs.

For 1½" posts, applicable kit is the 212 Series.
For 2" posts, applicable kit is the 232 Series.
For 2-3/8" posts, applicable kit is the 224 Series.
 The tensioning device is, respectively, a 1½", 2", or 2-3/8" long Receiver, which installs through the metal post on one end. A Pull-Lock fitting of the same length is installed through the other end.

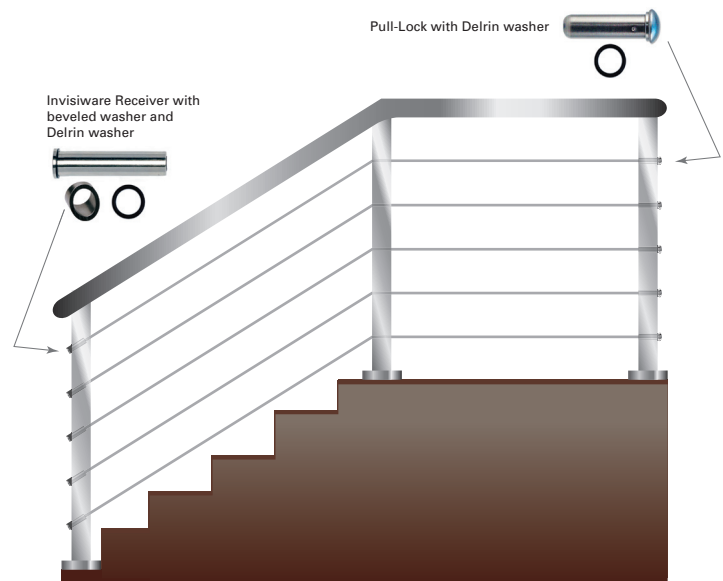
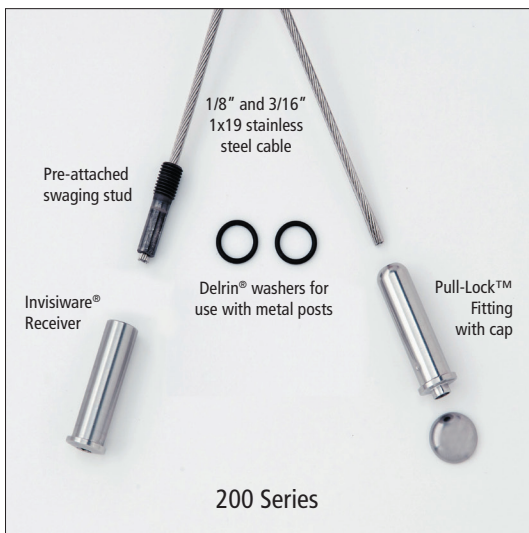
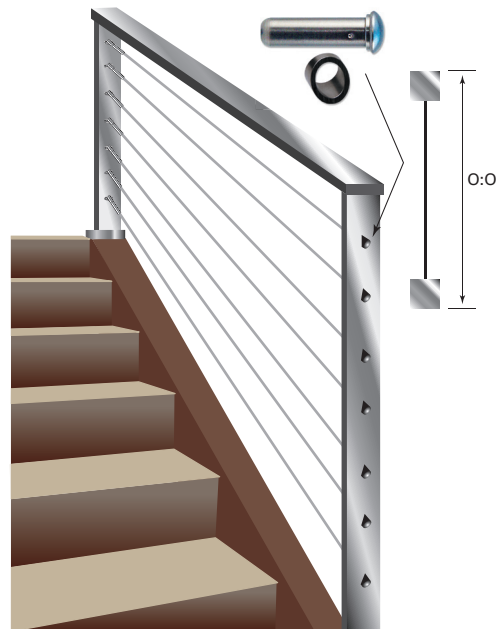

Tools needed for 212, 232, and 224 Series on stairs:

- 5/32 drill bit if 1/8" cable, 7/32 if 3/16"
- 29/64 drill bit for Receiver and Pull-Lock installation
- 3/16 Hex wrench for tensioning Receiver
- Cable cutting tool

Series 212, 232, and 224 Kits

Cable Length	1/8" cable			3/16" cable		
	1½" metal post	2" metal post	2-3/8" metal post	1½" metal post	2" metal post	2-3/8" metal post
	PART NO.	PART NO.	PART NO.	PART NO.	PART NO.	PART NO.
5'	21205	23205	22405	21205-6	23205-6	22405-6
10'	21210	23210	22410	21210-6	23210-6	22410-6
15'	21215	23215	22415	21215-6	23215-6	22415-6
20'	21220	23220	22420	21220-6	23220-6	22420-6
25'	21225	23225	22425	21225-6	23225-6	22425-6

For use on stairs, order two BW32-6 per kit.
 See Tools and Essentials section.

Budget Kits for 1/8" Cable

Fitting combinations for metal posts

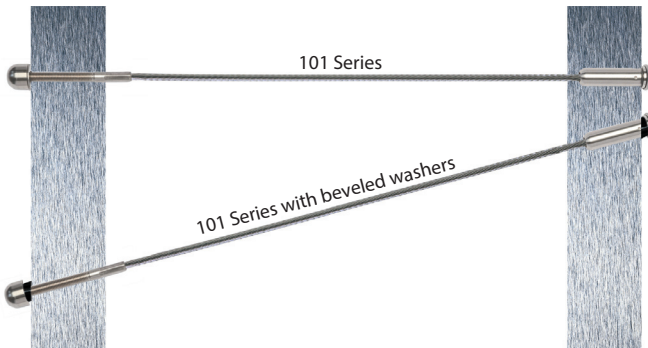

For level runs:

101 Series (outside to outside)
2 1/2" long threaded stud to Pull-Lock.

For stairs, pitched runs:

101 Series (outside to outside)
2 1/2" long threaded stud to Pull-Lock with beveled washers (BW-.250-32 for stud, BW32-6 for Pull-Lock).

Important Notes for Budget Kits:

- Outside attachments can only be used if your end posts are not obstructed on the back side.
- Corners require two posts because the cable itself, being rigid, will not cooperate in bending cleanly through a single post.
- When you go through a corner post (no more than 45° at any post), you will need to prevent the cable from slicing into the wood as it exits the post on an angle by using a Post Protector Tube (see Tools and Essentials section).
- If you are installing a railing with a pitch, you will need beveled washers for both ends.

Warranty: Stainless steel hardware and cable are covered by a limited warranty for a period of ten (10) years from the date of receipt to be free from defects due to defective materials and workmanship. For complete warranty details, please visit <http://thecableconnection.com/warranty-ultra-tec.html>

Outside-of-Post to Outside-of-Post Mount _____ Metal Posts

For metal posts, the applicable kit is the 101 Series.

The tensioning device is a 2 1/2" long threaded stud which installs on the back side of one end post, as shown in Deck 2.

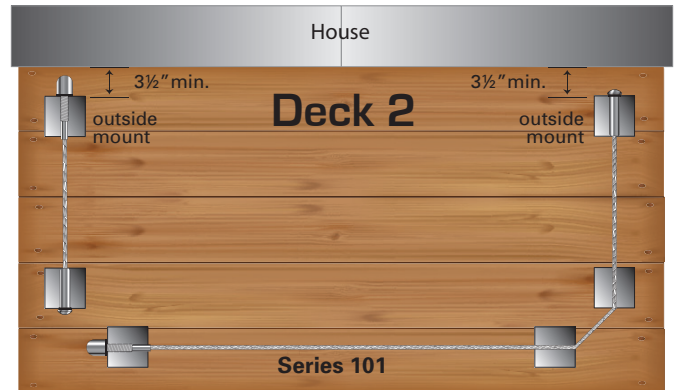
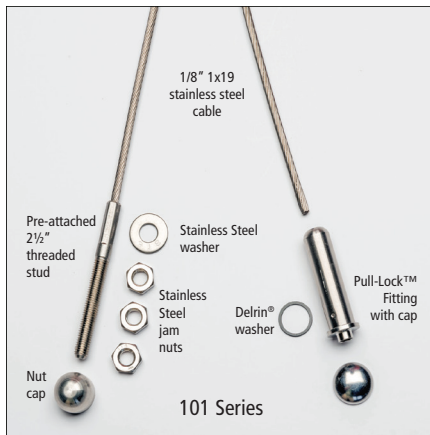

Series 101 Kits

Cable Length	PART NO.
5'	10105
10'	10110
15'	10115
20'	10120
25'	10125
30'	10130
40'	10140
50'	10150

Tools needed for 100 and 101 Series:

- 5/32 drill bit if 1/8" cable, 7/32 if 3/16"
- 9/32 drill bit for threaded stud installation
- 29/64 drill bit for Pull-Lock installation
- 7/32 wrench for holding the stud
- 7/16 wrench for tightening jam nuts
- Cable cutting tool

Tools and Essentials



Stainless Steel Cable Brace

1/4" x 1" in 2 lengths, for 36" and 42" high rails. Holes pre-drilled at 3-1/8" on center, 10 holes in short length, 12 in long. For use between structural posts to keep cables code compliant on level runs. Weld to metal frames; use cable brace floor plates for attaching to wood.

Order **CB-34.5-SS-10** or **CB-40.5-SS-12**

Stainless Steel Cable Brace for Stairs

1/4" x 1" in 2 lengths, for 36" and 42" high rails. Slots pre-drilled at 3-1/8" on center, 10 slots in short length, 12 in long. For use between structural posts to keep cables code-compliant on stair runs. Weld to metal frames; use cable brace floor plates for attaching to wood. Must be field-chamfered to match stair angle.

Order **CBS-34.5-SS-10** or **CBS-40.5-SS-12**

Stainless Steel Cable Brace Floor Plates

For mounting cable braces to top or bottom rail or deck. 2-1/4" x 1-1/4" x 1/4", #4 Finish Stainless Steel.

Order **FLP-CBS**

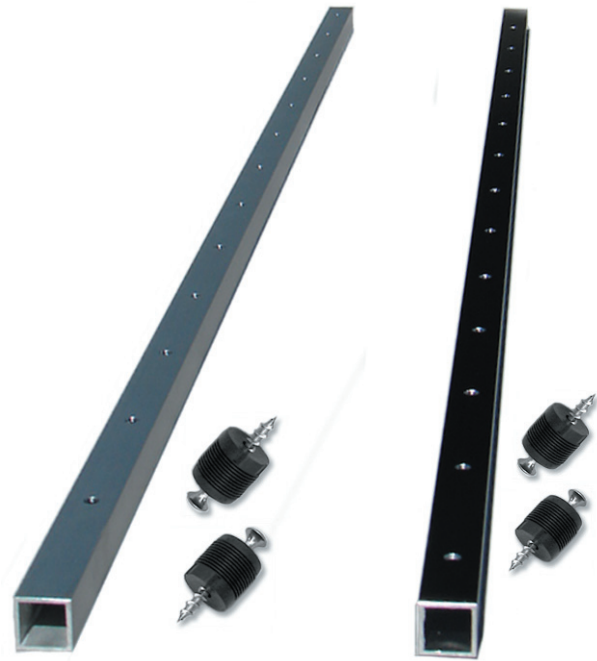
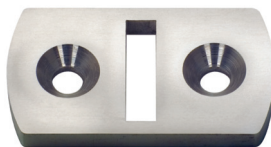

Anodized Aluminum Cable Brace

3/4" x 3/4" tube, 42" long for cutting down to any size rail height. Holes pre-drilled at 3-1/8" on center, 13 holes total. For use between structural posts to keep cables code compliant on level runs. Use cable brace plugs to attach to top and bottom rail or deck.

Order **CB-42-AN-AL-13-P**

Black Aluminum Cable Brace

Order **CB-42-BL-AL-13-P**

Anodized Aluminum Cable Brace for Stairs

3/4" x 3/4" tube, 42" long for cutting down to any size rail height. Comes undrilled so slots can be field-drilled to match cable array.

Order **CB-42-AN-AL-P**

Black Aluminum Cable Brace for Stairs

Order **CB-42-BL-AL-P**



Tools and Essentials

Beveled Washers

Made of stainless steel for use on stairways or slopes where you need to drill your end post holes at an angle.

For metal posts, order **two** of **BW32-6** per kit.

FOR BUDGET KITS:

For metal stairs, order **one** each of **BW-.250-32** and **BW32-6** per kit.



Cut-off Tool

Used to cut cable flush with the end of Pull-Lock fittings, and to cut excess threads off stud-type tensioners. Includes mandrel and two cut-off wheels.

Order **CUT-OFF KIT**



Cable Cutter

For burr-free cutting of cable.

For light-duty use to cut 1/8" diameter cable, order **C-7HIT**

To cut cable up to 1/4" diameter, order **C-9**



Cable Tension Gauges

Check the tension on your cables with these easy-to-use gauges.

Order **PT-CR** for cable diameter of 1/8", 3/16" and 1/4"



Cable Release

Releases cable from Push-Lock and Pull-Lock type fittings before cables are tensioned.

For 1/8" cable only.

Order **PL-KEY**



Stainless Steel Cleaner and Protectant

Dissolve minor corrosion, then leave a protective coating that lasts for months. Includes an 8-oz. spray-on rust and stain remover and a 4-oz. bottle of protectant.

Order **E-Z Clean**



Your Project

Make a bird's eye drawing of your project. Include railing lengths, end and corner post locations, stairs and any angles/turns your railing takes. Please include the following:

- ✓ What size post?
- ✓ What is the height of the railing?
- ✓ Are you using a bottom rail?
- ✓ Are you using single posts at corners or a double post configuration?
- ✓ Do you have 3-1/2" of space behind end posts to allow for installation of Receivers and Pull-Locks?
- ✓ What diameter cable are you using (1/8" or 3/16")?

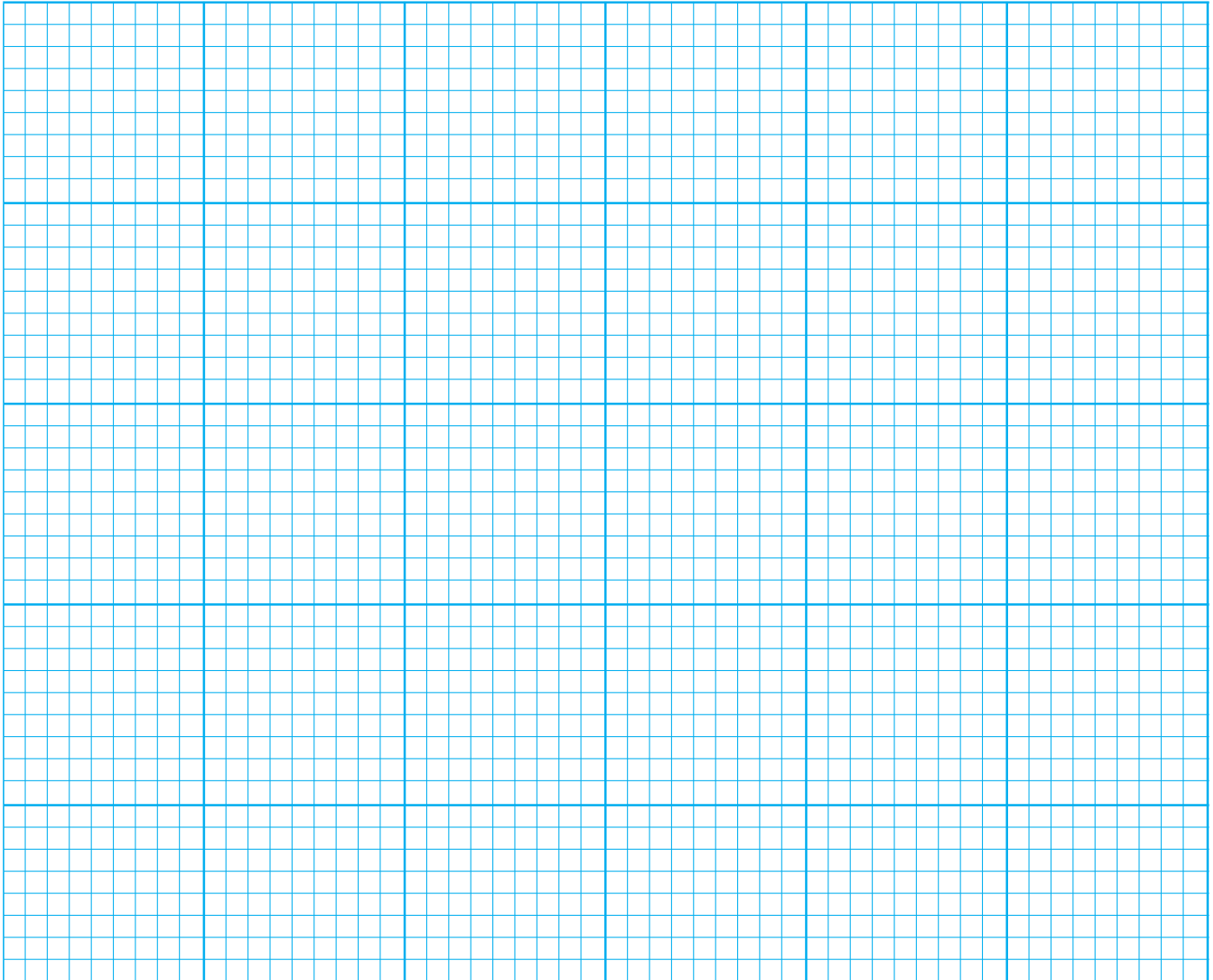

Ultra-tec® Cable Railing products are available through:



Looking for your nearest source for Ultra-tec Cable Railing Kits?

Visit our Website: <http://thecableconnection.com/wholesalers.html> or scan this QR code with your smartphone. You will be directed to wholesalers in your state who can point you to a participating local retailer.